

V-TUF[®]



HD140HOT

HOT WATER PROFESSIONAL
MOBILE PRESSURE WASHER

OPERATOR MANUAL



Please read this manual before using the HD140HOT

Congratulations! We wish to thank you

for buying this cleaner. You have shown that you do not accept compromises: you want the best. We have prepared this manual to enable to fully appreciate the qualities and high performance that this cleaner can offer you. Please read it completely before using the machine. The CE mark on your cleaner shows that it has been constructed in compliance with the European Standards on safety.

We can also offer you a wide range of cleaning machines such as: **VACUUM CLEANERS**, and a complete range of **ACCESSORIES, CHEMICALS** and **DETERGENTS** suitable for cleaning all kinds of surfaces.

Ask your Dealer for the complete catalogue of our products.

TRANSLATION OF ORIGINAL INSTRUCTIONS

The text has been carefully checked, however any misprints should be notified to the manufacturer. The manufacturer also reserves the right to alter and update this publication without prior notice for the sake of product improvement.

All reproductions of this manual, in whole or in part, are forbidden without the manufacturer's authorization.

PREPARING THE CLEANER

Fitting the handlebar

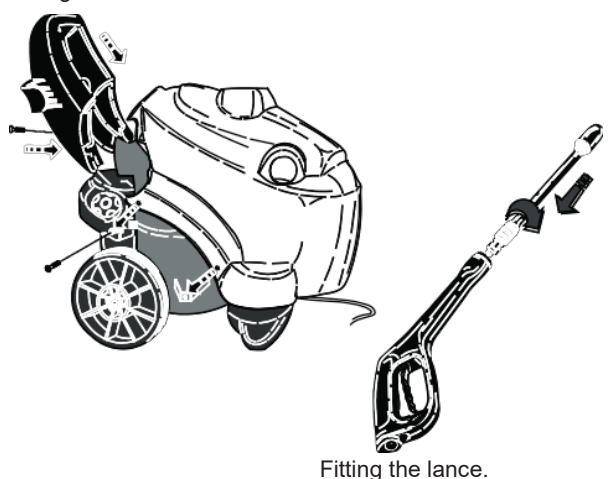

Fitting the rear tank.

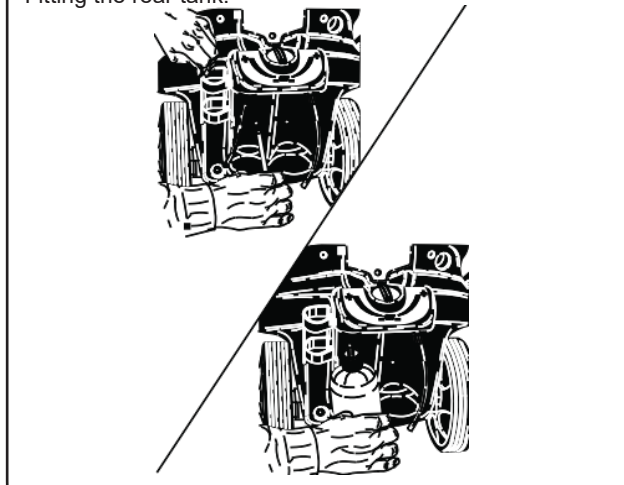

Water circuit connection.

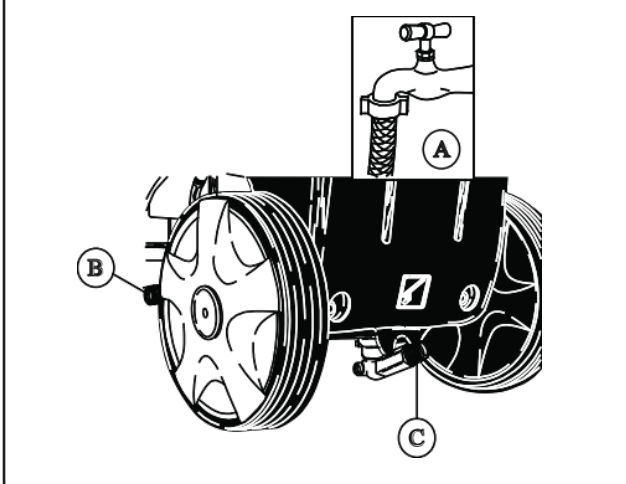

Electrical connection.

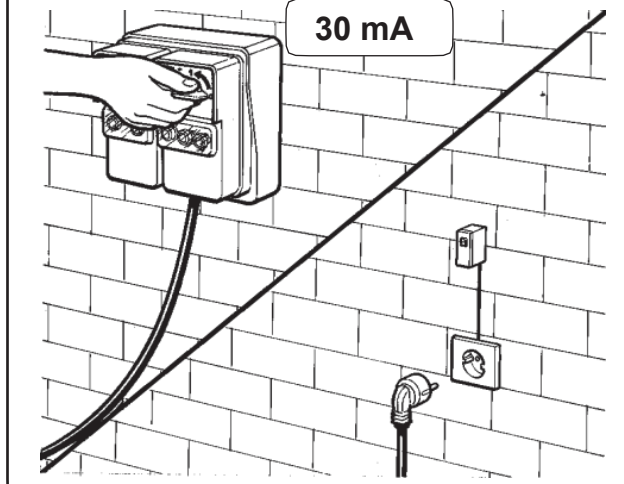

Continue reading this manual without connecting the cleaner to the power mains and the water supply.

DESCRIPTION OF SYMBOLS ON THE CLEANER

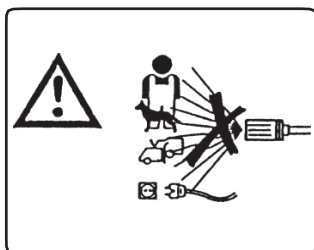

DO NOT DIRECT THE JET AGAINST PEOPLE, ANI- MALS, POWER SOCKETS OR THE MACHINE IT SELF.

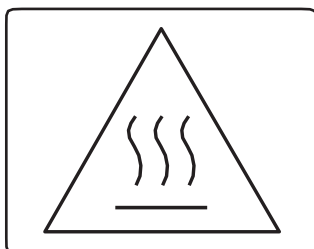

ATTENTION: RISK OF BURNS.

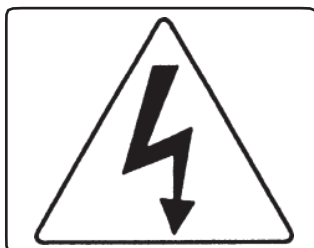

ATTENTION: RISK OF ELECTRIC SHOCK.



EARTH.

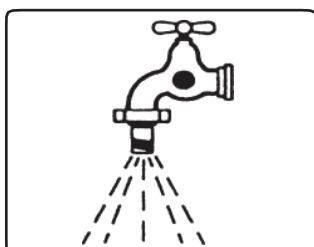

WATER INPUT

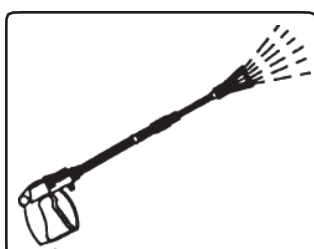

WATER OUTPUT



SWITCHING OF THE PUMP MOTOR.

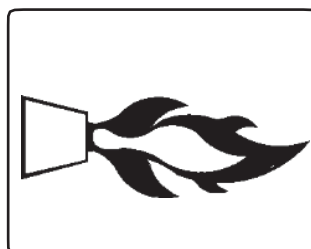

LIGHTING THE BURNER.

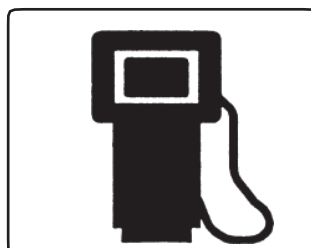

FUEL (DIESEL).



CHEMICALS (DETERGENT).

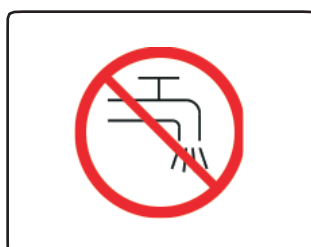

DO NOT FEED WITH DRINKING WATER. USE AN EN 12729 TYPE BA SYSTEM SEPARATOR.

CLASSIFICATION OF RISKS:

Danger

Identifies an imminent risk which could lead to serious or fatal injury.

Warning

Identifies a risk situation which could lead to serious injury.

Information

Identifies a risk situation which could lead to minor injury or damage to things.

PREFACE

Warning

You must read this manual before installing, starting up and using the high pressure washer. This manual is an integral part of the product.

Read the warnings and instructions contained in the manual carefully as they provide important information on **USER SAFETY** and **MAINTENANCE**, paying particular attention to the general safety regulations.

KEEP THIS MANUAL IN A SAFE PLACE FOR FUTURE REFERENCE.

Warning

Those operating and servicing the high pressure washer must be aware of the contents of this manual.

CLASSIFICATION

The user must observe the conditions of use of the appliance prescribed by the Rules, and particularly he must respect the following classification:

As for the protection against electric shock, the H.P. cleaner belongs to **CLASS I**.

The H.P. cleaner is factory set and all its safety devices are sealed. **It is forbidden to alter their adjustment values.**

In the Hot water cleaner the water is heated by a burner feed with **Diesel** fuel.

The H.P. cleaner must be always used on a firm and flat ground, furthermore it must not be moved while it is working or connected to the electric supply.

Failure to observe this prescription may cause danger for the user.

The H.P. cleaner must not be used in the presence of corrosive or potentially explosive atmospheres. (vapours or gas)

GENERAL SAFETY RULES FOR THE USE OF HIGH PRESSURE CLEANERS

Warning

- The electric connection must be performed by qualified technicians who are able to work in observance of the governing rules (in compliance with the provisions of the IEC 60364-1 standard) and of the manufacturer's instructions.

A wrong electric connection may cause damage to persons, animals or things, and the manufacturer cannot be considered responsible for these.

- The H.P. cleaners with power lower than 3 kW are equipped with a plug for connection to the electric supply.

In this case please check if the electric power system and the electric sockets are compatible with the max. power of the appliance indicated on the plate. (kW).

In case of doubt, please apply to qualified personnel. If the socket and the plug of the machine are not compatible, have the plug replaced with a suitable type by qualified personnel.

- Before connecting the machine make sure that the data indicated on the plate correspond to those of the electric supply.

- Do not use extensions to power the high pressure washer. If you use an extension, the plug and socket must be watertight. Unsuitable extensions may be dangerous.

- The electric safety of this machine may be assured only when it is properly connected to an efficient grounding system in accordance with the governing laws for electric safety. (In compliance with the provisions of the IEC 60364-1 standard)

- It is necessary to check this essential safety requisite. In case of doubt, ask for accurate control of the power system by qualified personnel.
The manufacturer may not be considered responsible for damages occurred because of the lack of the grounding system.
- The H.P. cleaner must be connected to the electric supply by means of an omnipolar switch with opening contacts of at least 3 mm. This switch must have electric features which are consistent with the appliance. (This requisite does not apply to H.P. cleaners with plug and electric power lower than 3 kW).
It is recommended that the electric supply to this machine should include a residual current device that will interrupt the supply if the leakage current to earth exceeds 30 mA for 30 ms or a device that will prove the earth circuit.
- The appliance is disconnected from the electric supply only by pulling out the plug or switching off the omnipolar switch.
- Failure to respect the above absolves the manufacturer of all liability and represents negligent use of the product.
The water cleaner is considered as a fixed device.
- Water cleaners with the "Total Stop" device should be considered as off when the omnipolar switch is in the "O" position or the plug is unplugged from the socket.
- The high pressure washer is not intended for use by children, adolescents or persons with reduced physical, sensory or mental capabilities, under the influence of alcohol or lacking experience and knowledge.
Operators must be made aware of the instructions for using the appliance by a person responsible for their safety. Children must be supervised to ensure they do not play with the high pressure washer.
- Use only original accessories that can allow safe working of the appliance.
- The flexible hose connecting the lance to the H.P. cleaner must not be damaged.
In case of damage, replace it immediately.
- Hoses, connections and fittings for high pressure systems are very important to guarantee the safety of the H.P. cleaner. Use only original spare parts which have the manufacturer's approval.
- Do not use the H.P. cleaner when persons or animals are in its of action field.
- High pressure jets may be dangerous if not properly used.
The jet must never be directed at persons or animals, electric appliances or at the appliance itself.

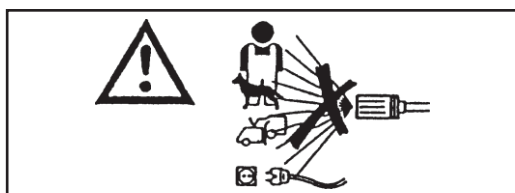

- The high pressure water jet causes a reaction power on the lance. Hold the lance grip vigorously.
- The use of the H.P. cleaner must be considered according to the kind of washing which must be performed.

Protect yourself against the ejection of solid materials or corrosive substances by means of adequate protective clothing.

- The use of the H.P. cleaner must be considered according to the place where the washing is performed (for example: food plants, pharmaceutical plants, etc.) Pertinent rules and safety conditions must be followed.
- Do not direct water jets at your own or other people's body in order to clean clothes or shoes.
- While working it is forbidden, to stop the trigger (lever) of the lance in delivery position.
- In the hot water H.P. cleaners a Diesel fuel burner is used for water heating. The use of other fuels is dangerous.
- Before starting any cleaning or maintenance operation, disconnect the machine from the electric and water supply networks.
- Periodically, at least once a year, have the safety devices checked by one of our service centres.
- The machine is for outdoor use. If the appliance is to be used in an enclosed space (not advisable), install a flue gas extraction system and guarantee adequate ventilation.
- The hot water cleaner must be supervised while it is working.
- Do not clog the openings or the ventilation grilles and the heat and smoke extraction systems in the hot water cleaners.
- Do not use the machine if the supply cable is damaged.
For the replacement of the damaged cable apply exclusively to one of our technical service centres.
The supply cable of this appliance must not be replaced by the user.
- The electric power cable must never be under mechanical tension and must be protected against accidental crushing.
- The use of any electric appliance requires the respect of some basic rules:
 - Do not touch the appliance with wet or damp hands or feet.
 - Do not use the appliance bare-footed or with unsuitable clothing.
 - Do not pull the supply cable or the appliance itself in order to disconnect the plug from the electric supply.
(For water cleaners rated at less than 3 kW fitted with plug).
- In case of damage or malfunction, switch off the appliance (disconnecting it from the water main and from the electricity main via the omnipolar switch or by unplugging the plug in the case of water cleaners rated at less than 3 kW) without tampering with it.
As for the protection against electric shock, the H.P. cleaner belongs to **CLASS I**.

Apply to one of our technical service centres.

Failure to observe the above warning frees the manufacturer from all responsibility and constitutes negligent use of the product

INTENDED USE

This appliance is intended exclusively for cleaning machines, vehicles, buildings and general surfaces suitable for treatment with a high pressure jet of detergent solution between 25 and 250 bar (360 - 3600 PSI).

This appliance has been designed for use with the detergents supplied or recommended by the manufacturer. The use of other detergents or chemicals may influence the safety of the appliance. This appliance must be used only for the purpose for which it was specifically designed.

All other uses are to be considered incorrect and therefore unreasonable.

Examples of unreasonable use:

- Washing surfaces not suitable for cleaning with a high pressure jet.
- Washing people, animals, electric equipment or the machine itself.
- Using unsuitable detergents or chemicals.
- Blocking the trigger (lever) of the lance in delivery position.

The manufacturer cannot be held responsible for any damage due to improper, incorrect or unreasonable use. As far as safety rules are concerned, the cleaners are manufactured according to the European Standard.

PRELIMINARY OPERATIONS

UNPACKING

After unpacking, ensure that the cleaner is undamaged. If in doubt, do not use the machine. Contact your dealer.

Packaging (bags, boxes, nails, etc) is potentially dangerous and should be kept out of reach of children. It should be disposed of or retained in respect of national environmental legislation.

FITTING THE SEPARATE PARTS OF THE MACHINE

All the fundamental parts and safety devices of the machine are assembled by the manufacturer. For reasons of packing and transport, some secondary cleaner parts are supplied separately. The user must fit these parts as explained in the instructions supplied in each assembly kit.

DATA PLATE:

The data plate bearing the main technical characteristics of your cleaner is located on the trolley and is always visible.

⚠ When buying your cleaner, ensure that it has an identification plate. If there is no plate, inform the manufacturer and/or the dealer immediately. Machines without a plate must not be used and the manufacturer declines all responsibility for them. Products without a plate must be considered anonymous and potentially dangerous.

FILLING THE FUEL TANK

Fill the tank with fuel for Diesel motors (fig. 1).

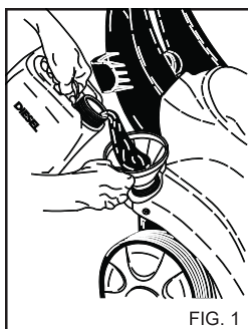

Warning

Do not use different fuel from that indicated on the identification plate. Check the fuel level from time to time while the cleaner is operating. Attempting to use the cleaner without fuel may cause damage to the fuel pump.

FILLING THE DETERGENT TANK

Warning

From the range of recommended products, choose the one most suited to the washing job to be done (fig. 2) and dilute it with water according to the instructions on the pack.

Fill the detergent tank with the diluted product (fig. 3).

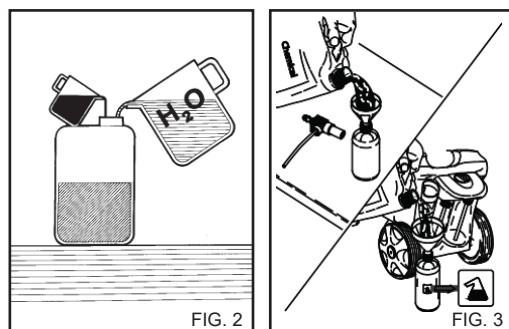

Ask your dealer for the catalogue of the detergents that can be used depending on the type of washing job to be done and the type of surface to be treated.

After using a detergent, the detergent intake circuit must be flushed out with clean water.

WAX-SOAP KIT (If available)

Select the desired tank by turning the selector appropriately. Detergent can only be delivered in the low-pressure position. (Fig. 4).

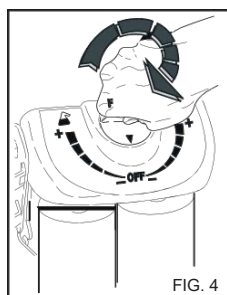

COMMAND AND CONTROL DEVICES

Warning

Before connecting the machine to the water supply and to the power mains, it is essential to know the function of the cleaner's command and control devices.

SAFETY DEVICES

The safety devices protect the user and the appliance. They must not be tampered with or used for other than their designated purpose.

Safety valve: protects the high pressure hydraulic circuit in the event of a by-pass valve malfunction or if the hydraulic circuit is blocked.

The safety valve is calibrated by the Manufacturer and sealed.

Operations involving the safety valve must be performed by a technical service centre only. **Safety device on lance handgrip:** Prevents the trigger on the handgrip from being operated accidentally.

Thermal cutout: stops the high pressure washer if the electric motor overheats.

WATER CIRCUIT CONNECTION

Connect the feed hose to the mains (fig. 5A) and to the hose detail on the cleaner (fig. 5B). Check that the pressure and quantity of the water supplied by the mains are sufficient for the cleaner to work properly: 200 to 800 kPa (29 to 116 PSI).

Maximum temperature of feeding water 50°C (122°F).

Connect the high pressure hose to the cleaner (fig. 5C) and to the lance (fig. 6).

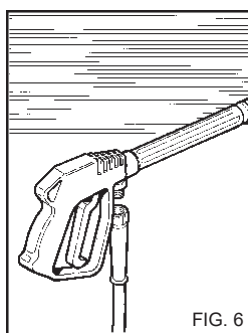
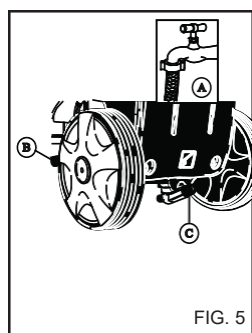

Danger

The cleaner must operate with clean water. Dirty or sandy water, corrosive chemicals and solvents can cause severe damage to the cleaner.

Danger

Never suck up liquids containing solvents or acids in the pure state, for example petrol, paint solvents or diesel. The spray mist from the lance is highly inflammable, explosive and poisonous.

Failure to respect the above absolves the manufacturer of all liability and represents negligent use of the product.



Information

Respect the instructions provided by the water utility company.

Current regulations specify that the appliance may not be connected to the drinking water supply unless a suitable system separator is fitted.

Use a suitable EN 12729 type BA system separator.

Water passing through a system separator is no longer classified as drinking water.

Warning

Do not connect the machine to a drinking water container.

ELECTRICAL CONNECTION

The water cleaner must be connected to a mains electricity supply conforming to current legislation and standards.

Ensure that the mains voltage available is the same as the voltage at which the cleaner is supposed to work; this is indicated on the identification plate.

⚠ Danger

- The electric cable must be protected from accidental crushing.
- Do not use the machine if the supply cable is damaged.
- The use of any electric appliance requires the respect of some basic rules:
 - Do not touch the appliance with wet or damp hands or feet.
 - Do not use the appliance bare-footed or with unsuitable clothing.
 - Do not pull the supply cable or the appliance itself in order to disconnect the plug from the electric supply. (For water cleaners rated at less than 3 kW fitted with plug).

As for the protection against electric shock, the H.P.cleaner belongs to **CLASS I**.

Failure to observe the above warning frees the manufacturer from all responsibility and constitutes negligent use of the product.

USING THE CLEANER

CONTROL PANEL

A - On/off switch

B - Detergent control tap (if available).

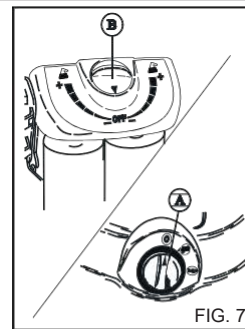

STARTING THE CLEANER

- 1) Turn on the water supply tap (fig. 5A).
- 2) Connect the water cleaner to the mains electricity supply by plugging the plug into the socket.
- 3) Start the cleaner by turning the selector switch to pos. I (fig. 7A).

⚠ Warning

The high pressure water jet generates a reaction force in the lance. Keep a firm grip on the lance handle.

- 4) Press the trigger on the gun and begin washing.
- 5) To operate the water cleaner with hot water, turn the ON/OFF switch to the Hot Water position. (fig. 7A).

⚠ Warning

In water cleaners with the "Total Stop" system, the motor starts and stops when the lever on the lance handle is actioned or released.

⚠ Danger

Do not block the handle lever in the delivery position.

IMPORTANT!

To eliminate any impurities or air bubbles from the water circuit we advise starting the cleaner for the first time without the lance and letting the water run out for a few seconds.

Impurities could block the nozzle and cause malfunction (Fig. 8).

USING THE ACCESSORIES.

USING THE MULTIREG ADJUSTABLE NOZZLE (fig. 9)

Pressure must be selected with the gun switched off.

Low pressure washing and detergent suction.
(Version with detergent suction).

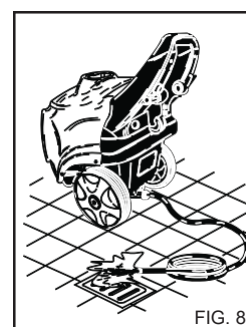

Washing at high pressure with a concentrated jet of water

Turn the nozzle in an anticlockwise direction.

Washing at high pressure with a fan-shaped jet of water

Turn the nozzle in a clockwise direction.

ROTARY HEAD (optional accessory) The high pressure washer can be fitted with a head with rotary nozzle to clean the most stubborn dirt.

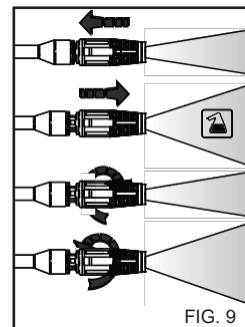

⚠ Danger:

Aim the jet from a certain distance to avoid damage caused by the high pressure. Do not aim the jet at people, animals or electrical sockets.

STOPPING THE CLEANER

- 1) Turn the burner off by rotating the ON/OFF switch to the "I" position (fig. 7A).
- 2) Let the cleaner run with cold water only for at least 30 seconds to cool down the boiler.
- 3) Stop the cleaner by turning the selector switch to pos. "0" (fig. 7A).
- 4) Discharge the pressure from the H.P. hose by pressing the trigger on the gun.
- 5) Disconnect the water cleaner from the mains electricity supply via the Solenoid switch or by unplugging the plug from the socket.
- 6) Turn off the water supply tap (fig. 5A).

⚠ Warning

- If the water cleaner is left, even temporarily, turn it off by using the Solenoid switch or by unplugging the plug from the socket.
- Water cleaners with the "Total Stop" device should be considered as off when the Solenoid switch is in the "O" position or the plug is unplugged from the socket.
- When the water cleaner is not used, close the safety device on the handle.(fig.10).
- Dry use of the water cleaner causes serious damage to pump gaskets.

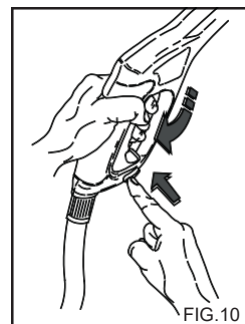

ADVICE ON USING DETERGENTS

⚠ Warning

This cleaner has been designed for use with the detergents supplied or recommended by the manufacturer.

The use of other detergents or chemicals may influence the safety of the cleaner.

- 1)** For environmental compatibility, we recommend a reasonable use of detergents, according to the instructions on the pack.
- 2)** From the range of recommended products, choose the one most suited to the washing job to be done and dilute it with water according to the instructions on the pack or in the catalogue of the detergents most suited for the type of hot or cold water cleaner.
- 3)** Ask your dealer for the detergents catalogue.

OPERATING PHASES FOR CORRECT CLEANING WITH DETERGENTS.

- 1) Prepare the solution of detergent at the concentration most suitable for the type of dirt and the surface that is to be washed.

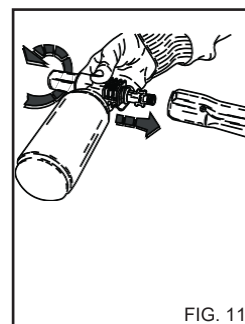

2) Remove the extension tube from the handgrip and attach the detergent spray kit (fig. 11), operate the water cleaner and spray the surface to be washed, starting from the bottom and working upwards.

In the version with detergent suction, open the detergent tap (fig. 7B) and move the nozzle forwards. Leave to work for a few minutes.

3) Rinse the whole surface well from top to bottom with hot or cold water at high pressure.

4) After use with detergent, rinse the high pressure water circuit by operating the pump for one minute with the detergent tap completely closed.

MAINTENANCE

ONLY THE OPERATIONS AUTHORIZED IN THIS INSTRUCTIONS MANUAL MAY BE CARRIED OUT BY THE USER. ALL OTHER OPERATIONS ARE FORBIDDEN.

Danger

For maintenance of the boiler, high pressure pump, the electrical parts and all parts with a safety function, you must apply to our Technical service centre.

The manufacturer is not liable in case of tampering, changes, in-correct repairs or maintenance carried out on the machine by a third person not provided with the manufacturer's authorization.

All documents pertaining to the repair and planned service interventions, as well as any certificates concerning the device installation according to the laws in force (in compliance with the provisions of the IEC 60364-1 standard) must be kept carefully by the user, together with the Instructions Manual.

Periodically, at least once a year, have the safety devices and the rated values checked at one of our technical service centres.

Particularly, as for the hot water high pressure cleaner, which is factory set, the exhaust system must be checked.

The rating done by the manufacturer determines a production of exhaust gases with a CO content lower than 0,04% and a smoke content corresponding to a smoke point nr.2 Shell-Bacharach according to the laws in force.

Danger

Disconnect the water cleaner from the mains electricity supply via the Solenoid switch or by unplugging the plug from the socket and close the water supply tap (see chapters on connecting to the electricity and water mains) before carrying out any maintenance jobs. To check to be able to verify the plug is disconnected from the supply socket. Once maintenance has been completed, ensure that the closing panels have been correctly reassembled and anchored with the screws provided before reconnecting the cleaner to the mains.

Failure to do so may cause a risk of electric shock.

PRECAUTIONS AGAINST FROST

The cleaner must not be exposed to frost.

If the cleaner is left in premises where it is exposed to frost, when work is over or for storage, antifreeze must be used to prevent serious damage to the hydraulic circuit.

OPERATIONS FOR USING ANTIFREEZE (fig. 12).

1) Turn off the water supply (tap), disconnect the hose and run the cleaner until it is completely empty.

2) Stop the water cleaner with the ON/OFF switch in the "O" position.

3) Prepare a container with the solution of antifreeze.

4) Immerse the tube in the container with the anti-freeze solution.

5) Start the water cleaner with the ON/OFF switch in the "I" position.

6) Start the cleaner and let it run until antifreeze comes out through the lance.

7) Suck up antifreeze with the detergent intake system too.

8) Disconnect the water cleaner from the mains electricity supply via the Solenoid switch or by

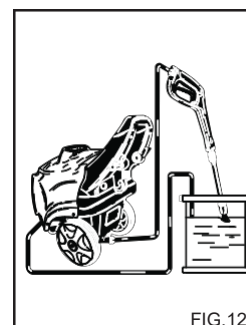

FIG.12

unplugging the plug from the socket.

Anti-freeze may cause environmental pollution. Always follow the instructions given on the pack. (Dispose of carefully.)

PUMP OIL CHANGE.

Contact our technical service centre for replacement.

CLEANING THE FUEL FILTER.

Remove and replace the in line fuel filter (fig. 13). Change it from time to time.

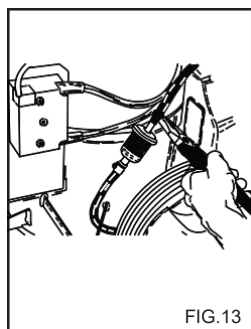

CLEANING THE WATER FILTER

Clean the water intake filter regularly and free it from any impurities (fig. 14).

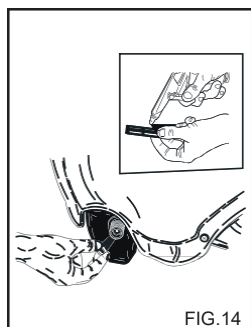

CHANGING THE NOZZLE

The high pressure nozzle fitted on the lance must be changed from time to time, as this component is subject to normal wear during use. Wear may generally be detected by a drop in the working pressure of the cleaner. To replace it, consult your supplier and/or dealer for instructions.

DESCALING

Descaling must be carried out from time to time because the scale present in the water partially deposits inside the hydraulic circuit and the coil which with time becomes clogged.

Apply to our technical service centre to have the machine descaled from time to time; this will save you money and increase the efficiency of the cleaner.

TABLE OF ROUTINE MAINTENANCE TO BE PERFORMED BY THE USER.

Description of operations:

Check power cable - pipes - high pressure connectors.	Each use
Change and clean fuel filters.	Every 100 hours
Clean fuel tank.	Every 100 hours
Clean water filter.	Every 50 hours

TABLE OF EXTRAORDINARY MAINTENANCE TO BE PERFORMED BY THE TECHNICAL SERVICE CENTRE.

Description of operations:

Boiler:

Clean Coil.	Every 200 hours
Descale coil.	Every 300 hours
Oil change in H.P. pump.	Every 500 hours
Clean fuel pump.	Every 200 hours
Change fuel nozzle.	Every 200 hours
Regulate electrodes.	Every 200 hours
Change electrodes.	Every 500 hours
Change seals on H.P. pump.	Every 500 hours
Change lance nozzle.	Every 200 hours
Calibrate and check the safety devices.	Once a year

IMPORTANT:

These intervals refer to normal working conditions. For heavy duty use decrease the interval for each job. For maintenance and/or repairs, use only original spare parts which offer the greatest characteristics of quality and reliability. Failure to use original spare parts absolves the manufacturer from all liability and transfers it to the person carrying out the operation.

PERIODS OF INACTIVITY

If the machine is to remain inactive for a long period, disconnect the supply sources, drain the tank(s) of all the operating fluids and protect any parts that could be damaged by the accumulation of dust.

Grease the parts that could be damaged by drying out, such as the supply hoses. When bringing back into use, ensure that there are no cracks or cuts in the water supply hoses.

Oil and chemical products must be disposed of according to current legislation.

SCRAPPING

If you no longer wish to use the water cleaner, you should render it unusable by removing the power cable.

You should also make sure that all potentially hazardous parts of the appliance are made safe, particularly for children who could play with the unused water cleaner.

This product is classified as WEEE type special waste and is covered by the requisites of the new environmental protection regulations. It must be disposed of separately from ordinary waste in compliance with current legislation and standards.

Do not use parts dismantled for scrap as spare parts.

TROUBLE-SHOOTING

Before carrying out any operations, disconnect the water cleaner from the mains electricity supply via the omnipolar switch or by unplugging the plug from the socket.

FAULTS	CAUSES	REMEDIES
When the switch is turned the cleaner does not start.	Faulty electric connection. Thermal protection has tripped.	Check the mains voltage. Reset (if it trips again, apply to the technical service centre).
No jet or leakage from high pressure water circuit.	Water supply filter clogged. Faulty connection to the mains water supply. Mains water supply tap closed. Leakage from high pressure circuit.	Clean. Check. Open. Contact Service Centre.
The pump functions but does not reach rated pressure.	Water supply filter clogged. Faulty connection to the mains water supply. Lance nozzle worn. Valves dirty or worn. Detergent tap open. Pressure adjustment devices on lance open (if present).	Clean. Check. Contact Service Centre. Contact Service Centre. Close. Close.
When the lance is open, the pressure drops and rises.	Nozzle clogged or deformed. Inadequate water supply.	Clean or contact Service Centre. Check.
When the ON/OFF switch to the Hot Water position, the boiler does not come on.	No diesel.	Check the level of diesel in the tank and make sure the fuel supply circuit is free of water.
Water not enough.	Filters clogged. Boiler element coated with scale.	Clean or replace. Contact Service Centre.
Excessive smoke from exhaust.	Incorrect combustion. Fuel contaminated with impurities or water.	Clean or replace diesel filters. Contact Service Centre. Empty the tank and clean thoroughly. Clean diesel filters.
Inadequate detergent suction.	Tap closed. No detergent. Element or tube clogged.	Open. Fill the detergent tank. Contact Service Centre.
Water leakage from head.	Gaskets worn.	Contact Service Centre.
Water in the oil.	Excessive humidity in atmosphere.	Contact Service Centre.

IMPORTANT:

For maintenance and/or repairs, use only original spare parts which offer the greatest characteristics of quality and reliability. Failure to use original spare parts frees the manufacturer from all responsibility.

V-TUF[®]

www.V-TUF.COM